



## UTS LC Series

BT 304



**SOURIAU**  
Connection Technologies





### Contents

Tool & Material .....	4	Assembly instructions for UTS718LCN .....	12
UTS LC component details .....	5	Cleaning & inspection .....	14
UTS LC dimensions .....	5	Safety considerations .....	15
Assembly Instructions for			
UTS1JC18LCN & UTS6JC18LCN .....	6		
A - Cable preparation .....	6		
B - Backshell screwing for UTS1JC18LCN .....	9		
C - Backshell screwing for UTS6JC18LCN .....	10		

## Tool & Material

The following tools and materials are necessary for preparation, assembly, inspection, and maintenance of the connector and cable assembly. Follow the tool instruction for operation and safety guidelines.

### Tools

- Cable jacket strip tool
- Aramid Fiber Shears
- Fiber Stripping Tool
- 15 mm U-wrench
- 28 mm U-wrench
- 36.5 mm U-wrench
- Nipper (Oeticker Standard pincers with straight jaws 14100082)
- Heat gun (optional)

### Material

- LC contact: the UTS LC connector range can adapt all kind of LC contact as defined per IEC 61754-20
- Cable: the UTS LC connector range can adapt all type of standard cable from 3 to 6mm outer diameter.
- Above these diameter limits some adaptations are necessary
- Suggested glue: LOCTITE® 480 PRISM Instant Adhesive

### Assembly instructions

The assembly should be done in a dust free and dried environment, in accordance with fiber optics good practices. Make sure that all components are free from contamination.

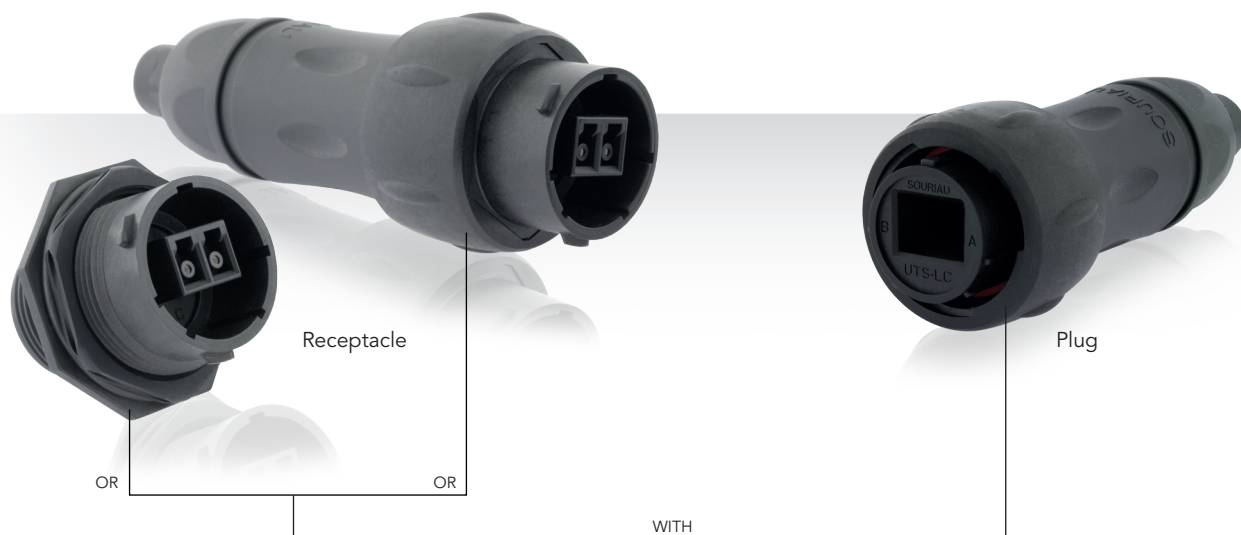

The assembly instruction is only a guideline and the assembly/manipulations are under the responsibility of the assembler. Any change of product or material is under the responsibility of the assembler.



## Connector part numbers

Connector type	Backshell	Part number	
		Male insert	Female insert
Free hanging receptacle	Cable gland	<b>UTS1JC18LCN</b>	-
Plug	Cable gland	-	<b>UTS6JC18LCN</b>
Jam nut receptacle	Without	<b>UTS718LCN</b>	-

## Accessories

Sealing caps					
<p>For UTS6JC18LCN</p> 	<p>For UTS1JC18LCN &amp; UTS718LCN</p> 				
<table border="1"> <tr><th>Part number</th></tr> <tr><td><b>UTS618DCG2</b></td></tr> </table>	Part number	<b>UTS618DCG2</b>	<table border="1"> <tr><th>Part number</th></tr> <tr><td><b>UTS18DCG2</b></td></tr> </table>	Part number	<b>UTS18DCG2</b>
Part number					
<b>UTS618DCG2</b>					
Part number					
<b>UTS18DCG2</b>					

## Dimensions

### Free hanging receptacle - UTS1JC18LCN

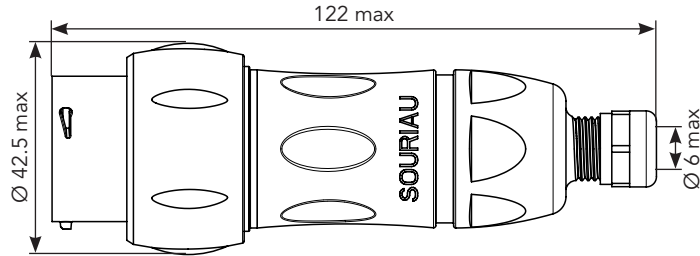

### Plug - UTS6JC18LCN

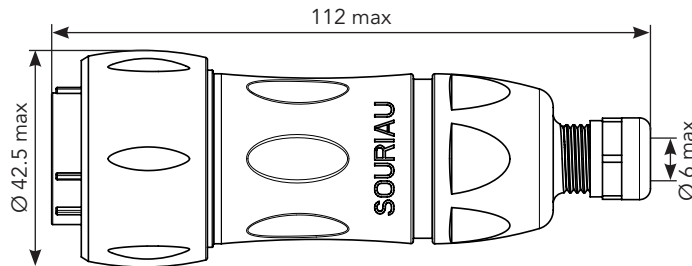

### Jam nut receptacle - UTS718LCN

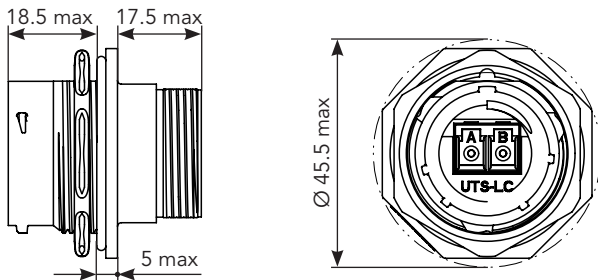

### Sealing caps

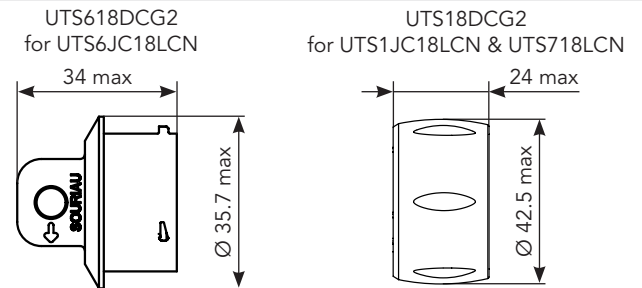

### UTS1JC18LCN, UTS6JC18LCN, UTS718LCN overview

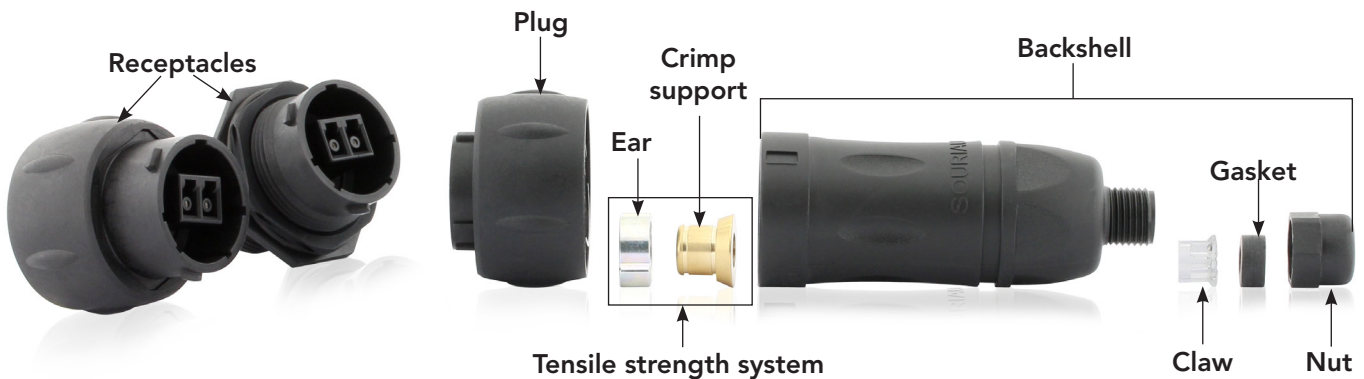

Note: all dimensions are in mm

## Assembly instructions

### UTS1JC18LCN & UTS6JC18LCN

#### Cable preparation

1. Slide the backshell onto the cable allowing 50 cm at the end of the cable for stripping the cable. Make sure to orient each component as shown in the UTS LC Component details section.
2. Using the cable jacket strip tool, strip the jacket to the dimension given in figure below, exposing the kevlar strength members and fiber.
3. Using the shears, trim the kevlar strength members to the length given in figure below.

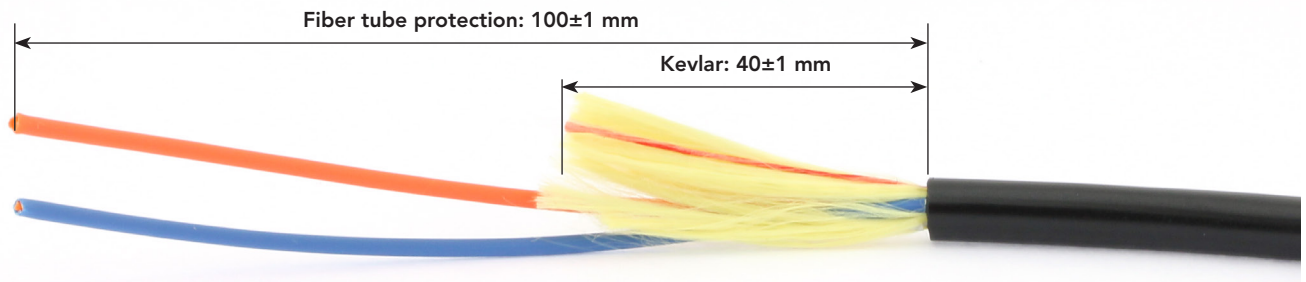

4. Fix the Kevlar using an adhesive tape on the "individual fibers" to facilitate the insertion of the crimp support.



5. Slide the crimp support (large diameter end first) over the fibers and the kevlar strength members until it bottoms on the cable outer jacket.



6. Separate the kevlar strength members in two groups. Use an adhesive tape to fix the kevlar strength members on the jacket.

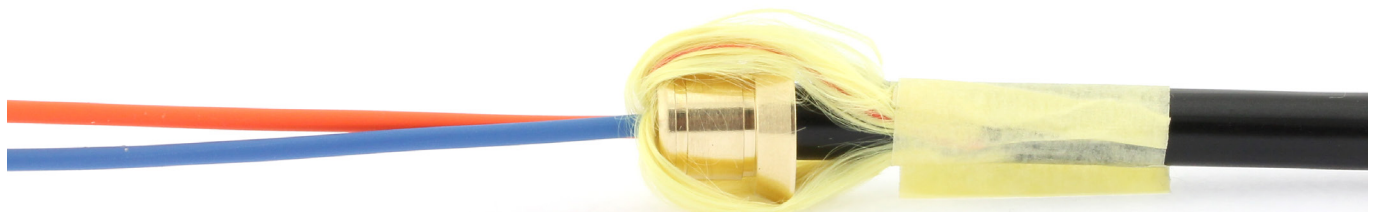

### UTS1JC18LCN & UTS6JC18LCN (Continued)

7. Apply the instant adhesive on the fiber and cover the crimp support. (e.g. Loctite 480 PRISM).

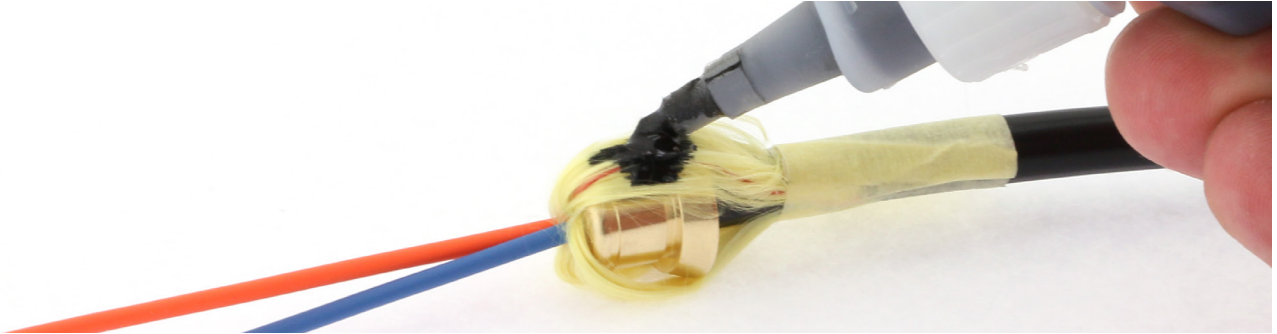

8. Before the instant adhesive begins to harden, quickly slide the ear clamp over the fiber, orient the Clamp according the picture. Push the strength members back over the clamp until it bottoms on the rear flange of the support.

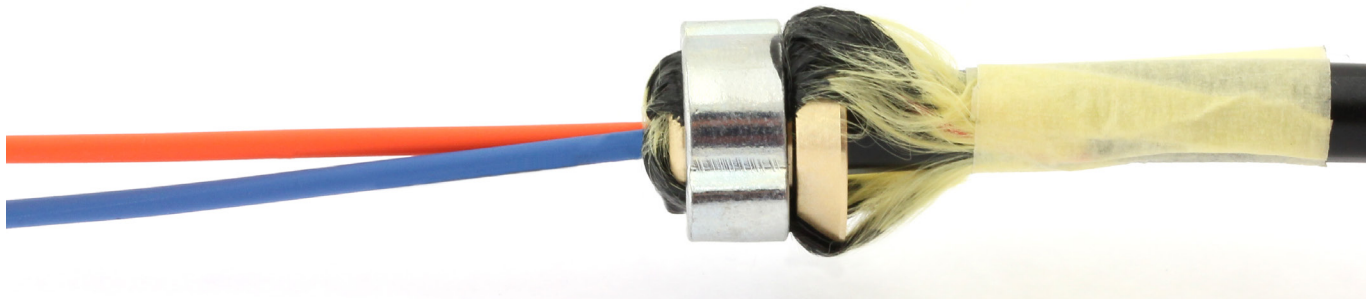

9. Crimp the both ear of the Clamp using the Nipper. Remove the kevlar strength members using using the shears.

Check the good crimping by pulling manually.



10. Strip the fiber buffer according to your LC supplier recommendations and make sure to reach the final desired lengths for the individual fibers as described on the pictures below.

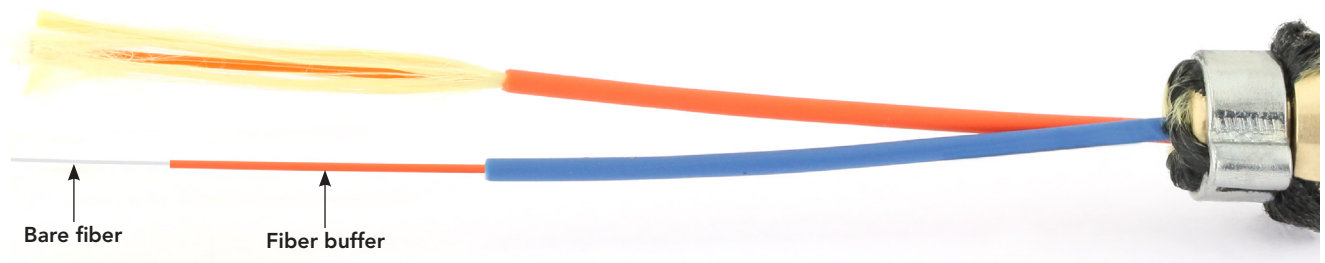

## Assembly instructions (Continued)

### UTS1JC18LCN & UTS6JC18LCN (Continued)

11. Terminate the LC contact on the fiber according to your supplier instruction for gluing, cliving and polishing.

Free hanging receptacle UTS1JC18LCN

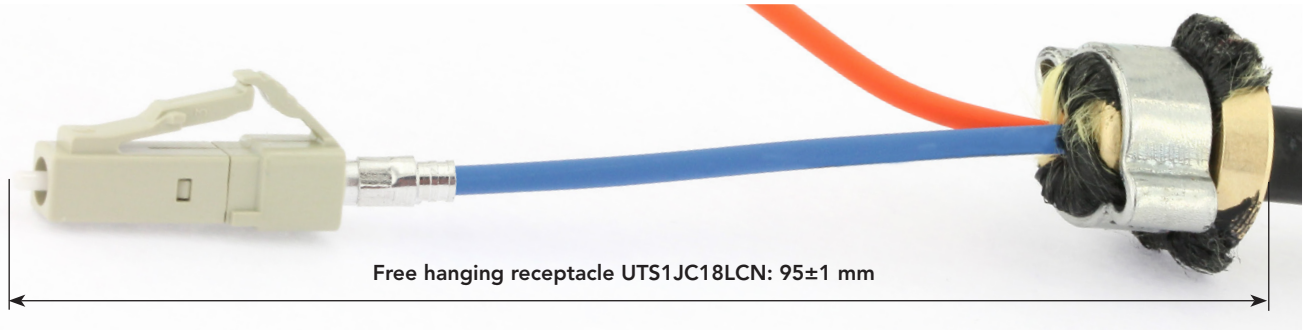

Plug UTS6JC18LCN

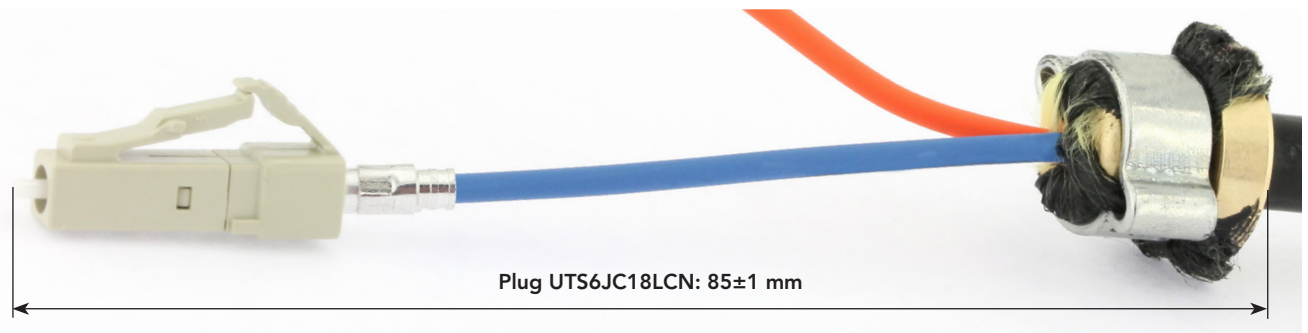

12. Fix the cable in a tool to avoid the rotation.





### UTS1JC18LCN & UTS6JC18LCN (Continued)

13. Plug the two LC: Make sure that each LC contact is in the right cavity A or B.

You need to hear a "click".

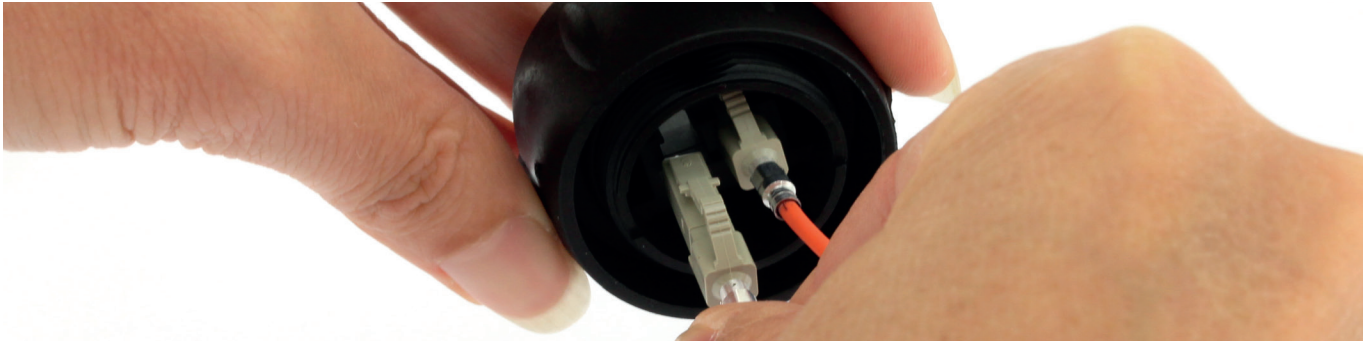

### Backshell screwing for UTS1JC18LCN

1. Slide the backshell and screw it using a 28 mm U-wrench. Tightened the backshell with a 4 Nm torque.



2. Control: Pull on the cable to ensure that the retention system bottoms in the backshell.



3. Screw the head nut using a 15 mm U-wrench. Tightened the head nut with a 2 Nm torque.



## Assembly instructions (Continued)

### Backshell screwing for UTS6JC18LCN

1. You need a receptacle counter-part. Orient the polarization keys before you start mating the connectors.

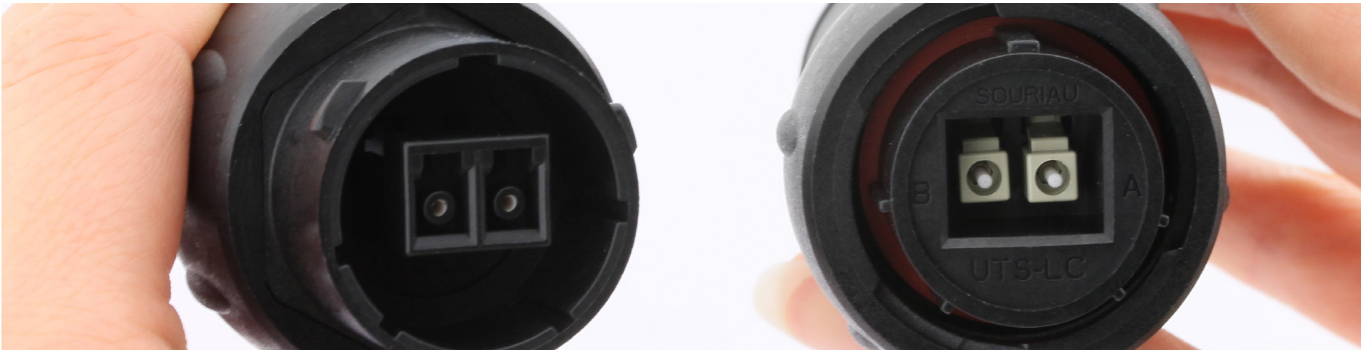

2. Coupling plug with receptacle



3. Slide the backshell and screw it using a 28 mm U-wrench. Tightened the backshell with a 4 Nm torque.



4. Control: Pull on the cable to ensure that the retention system bottoms in the backshell.



### Backshell screwing for UTS6JC18LCN (Continued)

5. Screw the head nut using a 15 mm U-wrench. Tightened the head nut with a 2 Nm torque.



### Recommendation

Use the caps, UTS618DCG2 for plug or UTS18DCG2 for receptacle to protect the LC contacts from surrounding contamination.

You need to hear a "click".



## Assembly instructions (Continued)

### Assembly instructions for UTS718LCN

1. Strip the fiber buffer according to your LC supplier recommendations and make sure to reach the final desired lengths for the individual fibers as described on the pictures below.

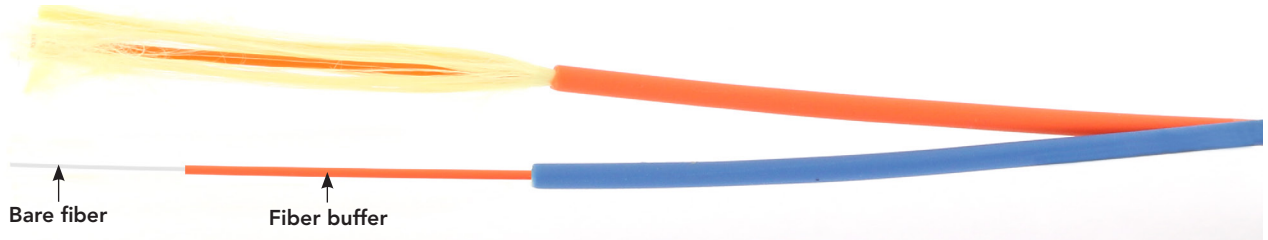

2. Terminate the LC contact on the fiber according to your supplier instruction for gluing, cliving and polishing.

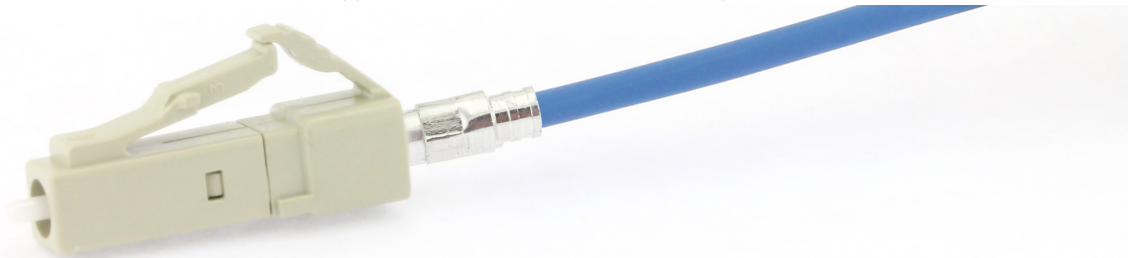

3. Plug the two LC in the receptacle. Make sure that each LC contact is in the right cavity A or B.

You need to hear a "click".



4. Seat o-ring, place receptacle in the panel cut-out.

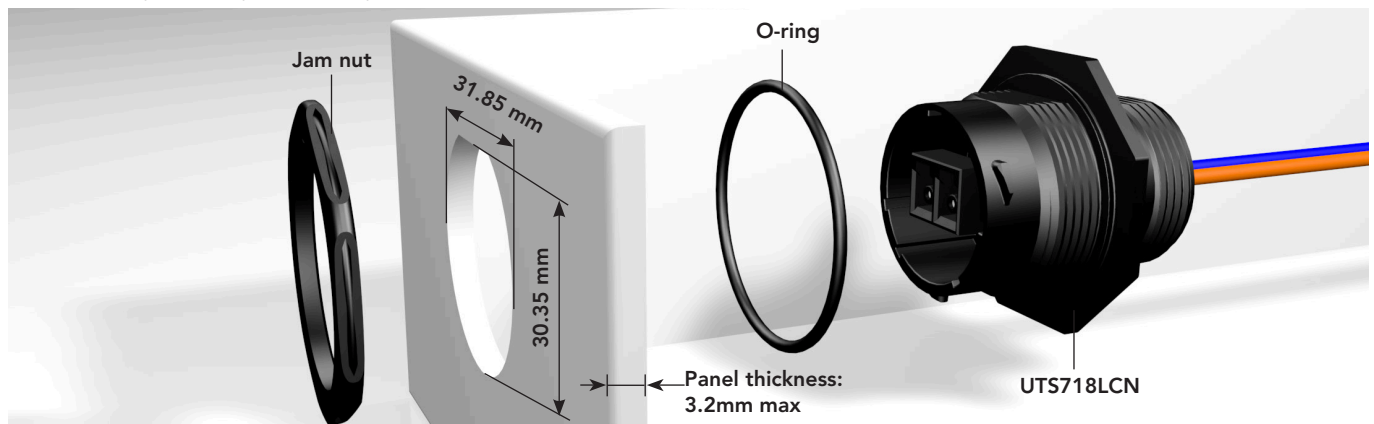

### Assembly instructions for UTS718LCN (Continued)

5. Tightened the jam nut with a torque of 5 Nm, using a 36.5 mm U- wrench.

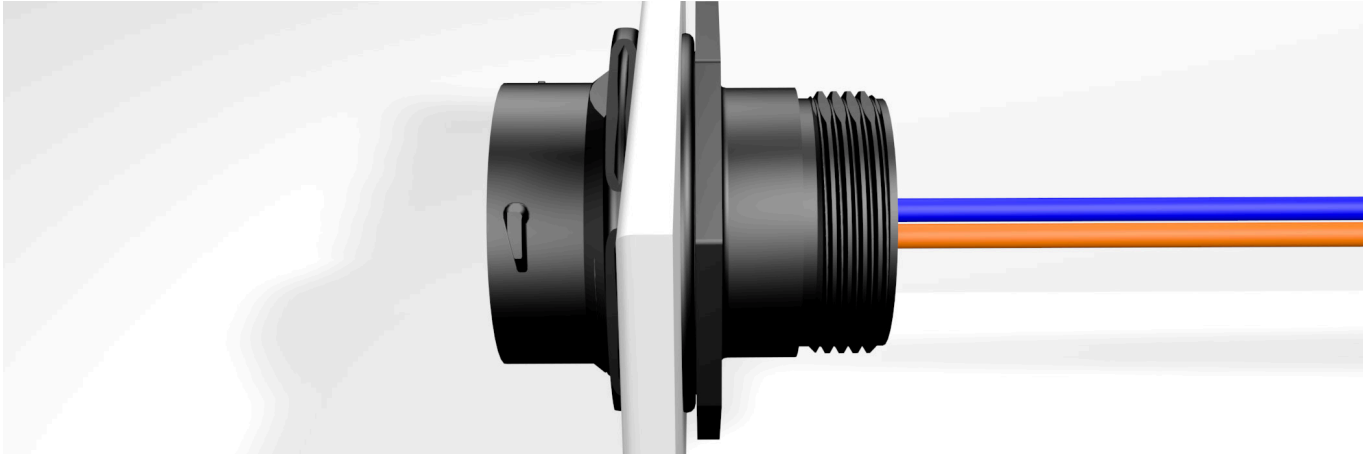

6. Coupling.



## Maintenance

### Cleaning & inspection

Cleaning and visual inspection of a termini endface is part of the good practices for fiber optics. This is necessary to ensure the good optical performances of an LC contact inside a UTS LC connector. Please note that most of the standard inspection and cleaning tool on the market can be used for maintenance of an LC contact mounted in an UTS LC connector.

#### 1 Inspection

- A- Use a fiber optic video probe (magnification X200 minimum) to inspect the termini endface for contamination, chips, pits, scratches and shatters in the core and in the inner of the cladding (see figure below).

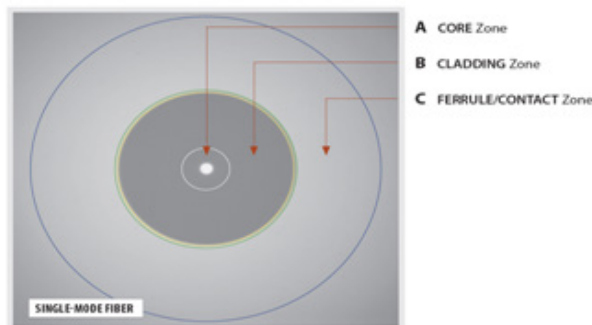

- B- If dirt, debris or other surface contamination is identified then clean (see below).

#### 2 Cleaning

- A- Use a lint free tip moistened with 99% reagent grade isopropyl alcohol or optical quality cleaning fluid to clean the termini endface. Always wipe in one direction, not back and forth.
- B- Dry the termini endface with a dry tip.
- C- Re-inspect the termini endface with a fiber optic video probe (Magnification x200 minimum) and verify that the contamination has been removed.
- D- If the contamination is still present then repeat step A & B.
- E- If after repeated attempts, the contamination is still present and cannot be removed like minor scratches, chips or pits then re-polish the optical contact (refer to the LC supplier instruction).

E.g. Magnification X 400 of two multimode fibers

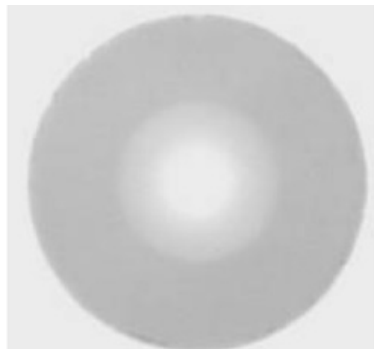

Clean and good termini endface



Contaminated or scratched termini endface

For more details, please refer to the acceptance criteria and cleaning procedures defined by IEC for multimode or singlemode connector termini endface

## Safety considerations

### Safety glasses

- A- Safety glasses to protect your eyes from accidental injury are strongly recommended when handling chemicals and cutting fibers. Pieces of glass fiber are very sharp and can damage the cornea of the eye.
- B- Glue  
Glue may cause eye and skin irritation. Avoid contact with eyes, skin or clothing. Avoid prolonged or repeated breathing of vapor. Use with adequate ventilation.
- C- Fiber Precautions  
Cleaved glass fibers are very sharp and can pierce the skin easily. Do not let cut pieces of fiber stick to your clothing or drop in the work area where they can cause injury later. Use tweezers to pick up cut or broken pieces of the glass fibers and place them in a debris container. Keep your work area clean.
- D- Laser Precautions.  
Laser light is invisible and can damage your eyes. Never look into the end of a fiber which may have a laser coupled to the opposite end.

# Reliable People, Reliable Solutions



[www.souriau.com](http://www.souriau.com)  
technical.americas@souriau.com (Americas)  
technical.emear@souriau.com (Europe - Asia - Africa)

